	DEKO	Projekt/Project:	
	Tlf./Tel: +45 43 55 77 11 www.deko.dk / www.deko.com	DEKO PF 1290	
Sags Nr./Case No.:	Emne/Subject:	Dato/Date:	Tegn. Nr. Sheet No. 1/1
Mål/Scale 1:1	Stolpesamling V1A	Revideret/Revision: 2016-05-01-V01	Signatur Signature OP/EZ

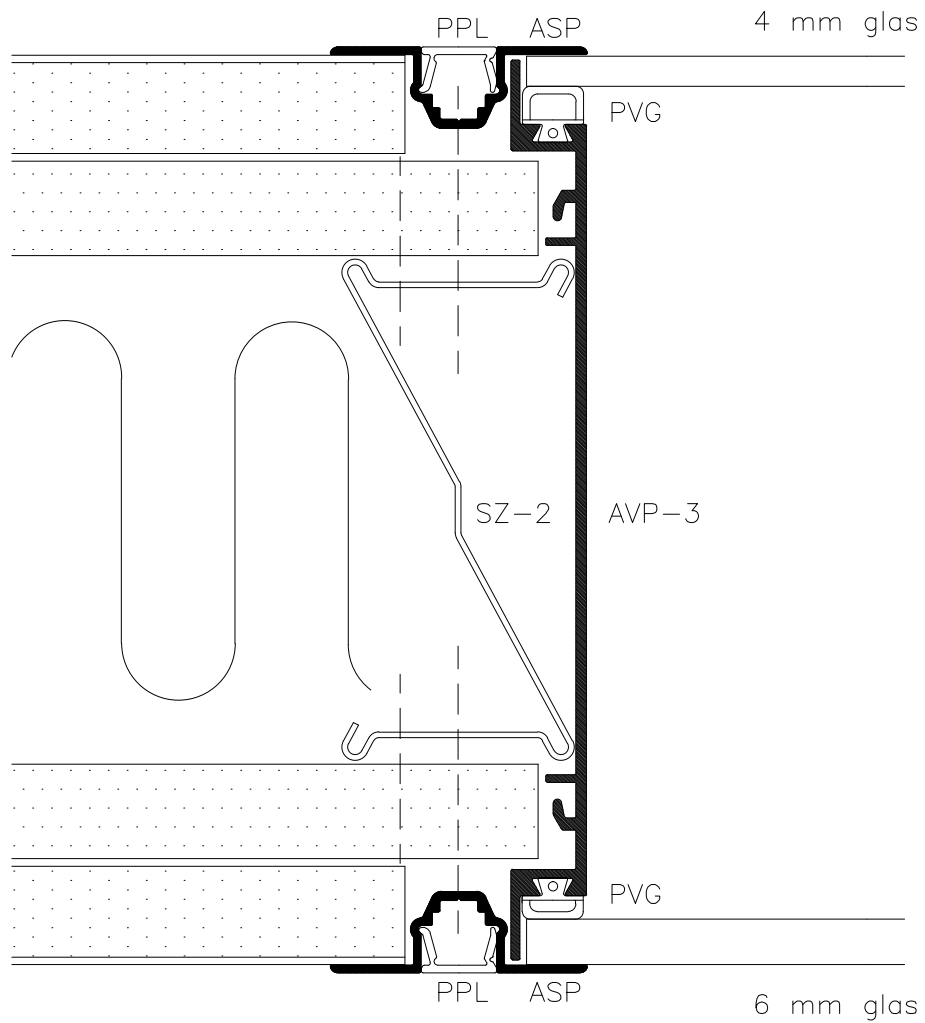

DEKO

Tlf./Tel: +45 43 55 77 11
 www.deko.dk / www.deko.com

Projekt/Project:

DEKO PF 1290

Sags Nr./Case No.:

Emne/Subject:

Stolpesamling
 V1B

Dato/Date:

Tegn. Nr.

Sheet No. 1/1

Mål/Scale
 1:1

Revideret/Revision:
 2016-05-01-V01

Signatur OP/EZ
Signature

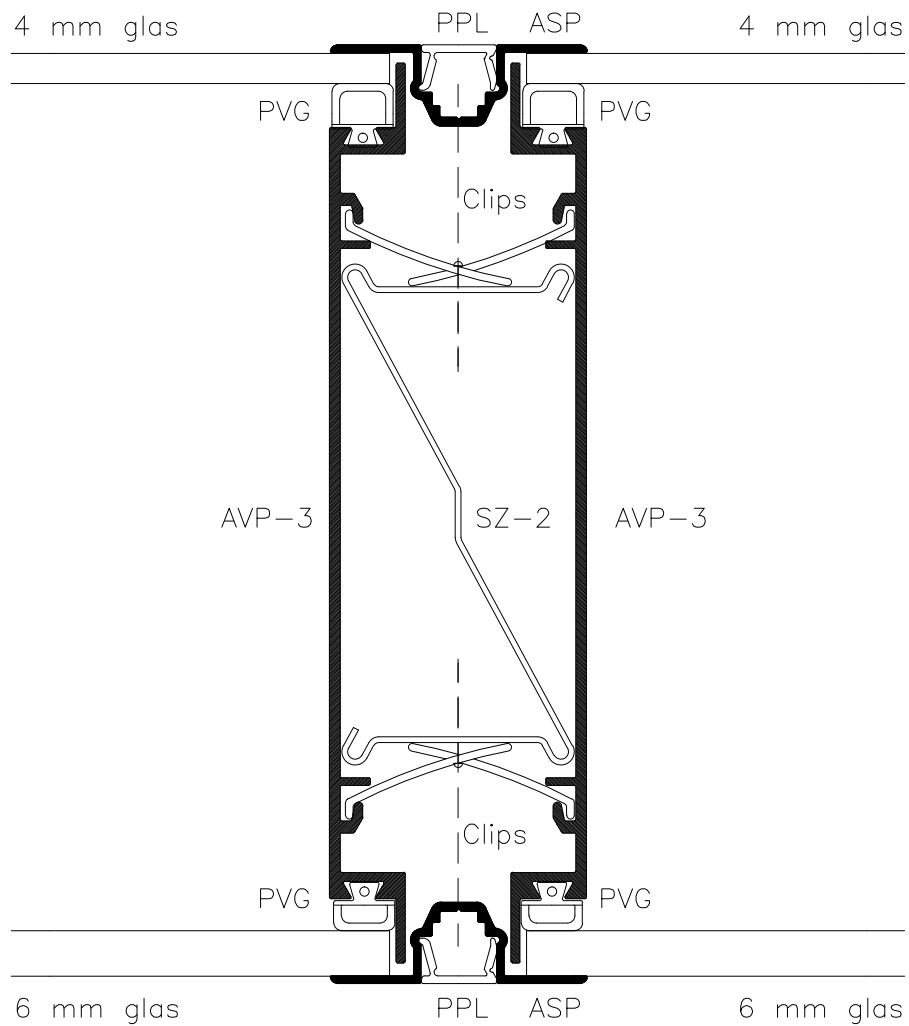

	DEKO Tlf./Tel: +45 43 55 77 11 www.deko.dk / www.deko.com		Projekt/Project: DEKO PF 1290		
	Sags Nr./Case No.:	Emne/Subject: Stolpesamling VIC		Dato/Date:	Tegn. Nr. Sheet No. 1/1
Mål/Scale 1:1			Revideret/Revision: 2016-05-01-V01	Signatur Signature OP/EZ	

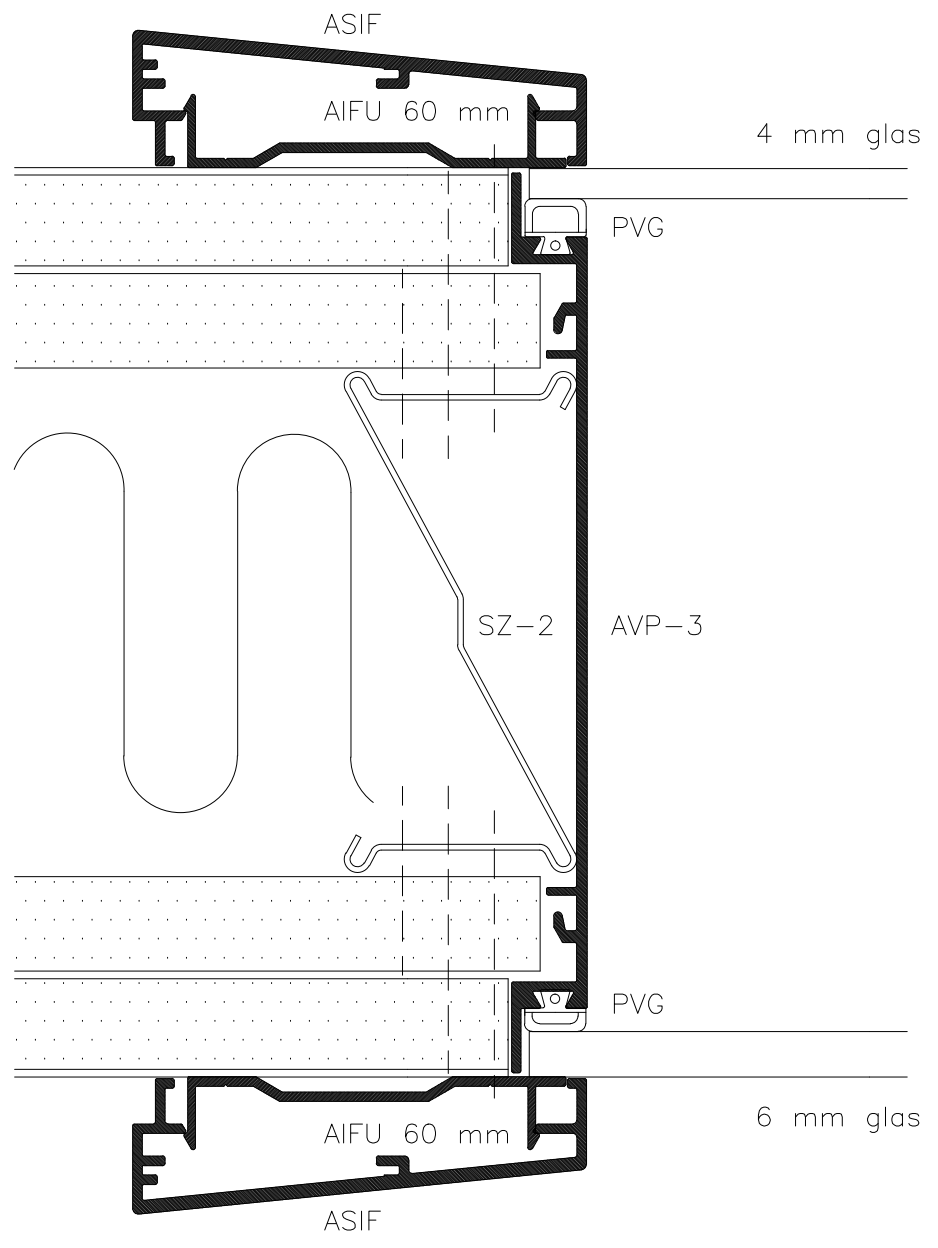

	DEKO Tlf./Tel: +45 43 55 77 11 www.deko.dk / www.deko.com	Projekt/Project: DEKO PF 1290	
	Sags Nr./Case No.:	Emne/Subject: Stolpesamling V1D	Dato/Date:
Mål/Scale 1:1		Revideret/Revision: 2016-05-01-V01	Signatur Signature OP/EZ

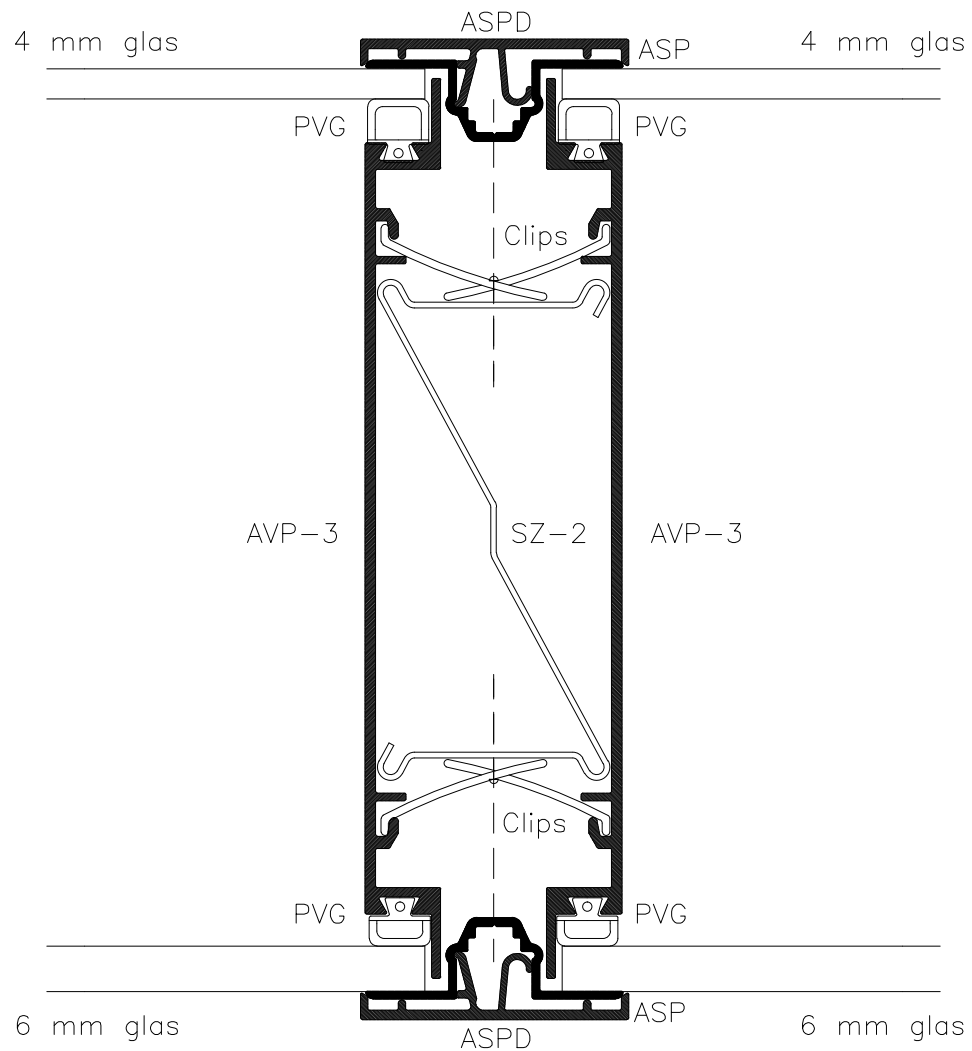

DEKO
 Tlf./Tel: +45 43 55 77 11
 www.deko.dk / www.deko.com

Projekt/Project:
 DEKO PF 1290

Sags Nr./Case No.:

Emne/Subject:
 Stolpesamling
 V1E

Dato/Date:

Tegn. Nr. Sheet No. 1/1

Mål/Scale
 1:1

Revideret/Revision:
 2016-05-01-V01

Signatur OP/EZ

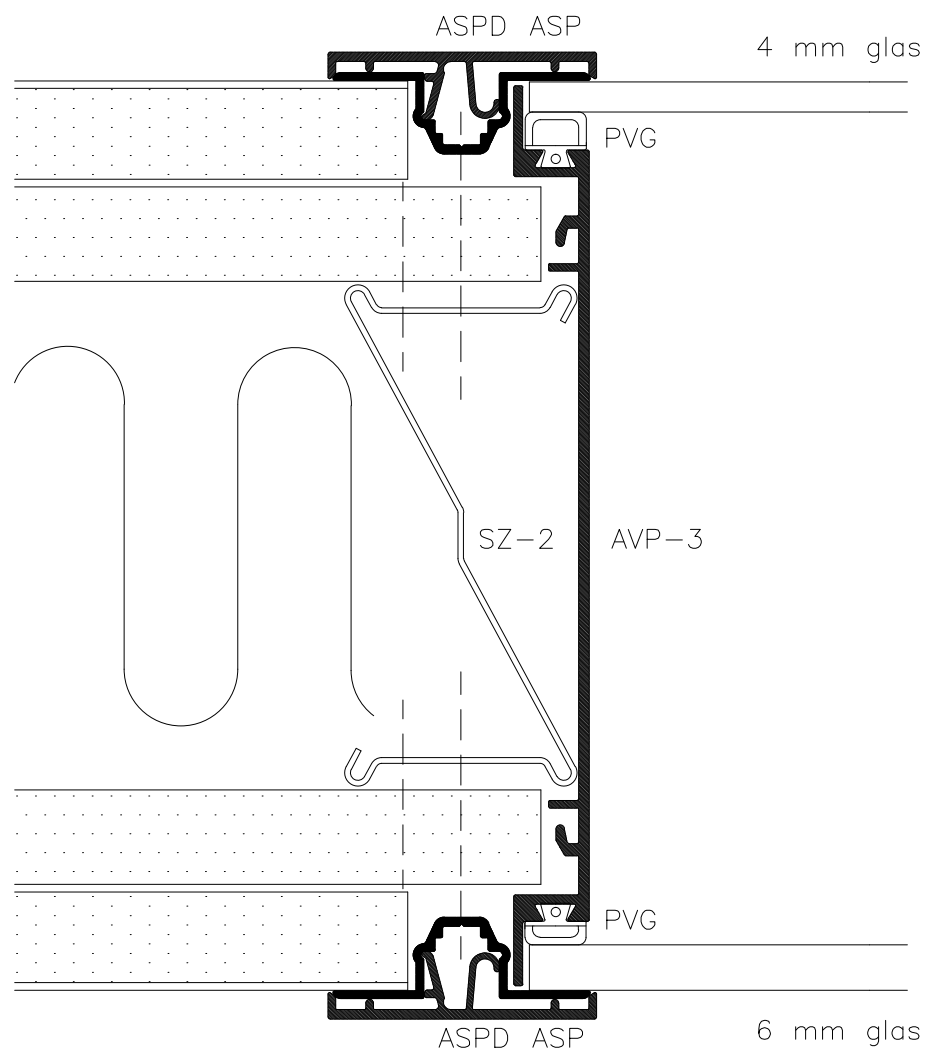

DEKO
 Tlf./Tel: +45 43 55 77 11
 www.deko.dk / www.deko.com

Projekt/Project:
 DEKO PF 1290

Sags Nr./Case No.:
Mål/Scale
 1:1

Emne/Subject:
 Stolpesamling
 V1F

Dato/Date:
Revideret/Revision:
 2016-05-01-V01

Tegn. Nr. Sheet No. 1/1
Signatur Signature OP/EZ