	DEKO Tlf./Tel: +45 43 55 77 11 www.deko.dk / www.deko.com		Projekt/Project: DEKO PF 1290	
	Sags Nr./Case No.:	Emne/Subject: Gulvtilslutning L3A		Dato/Date:
Mål/Scale 1:1			Revideret/Revision: 2016-05-01-V01	Signatur Signature OP/EZ

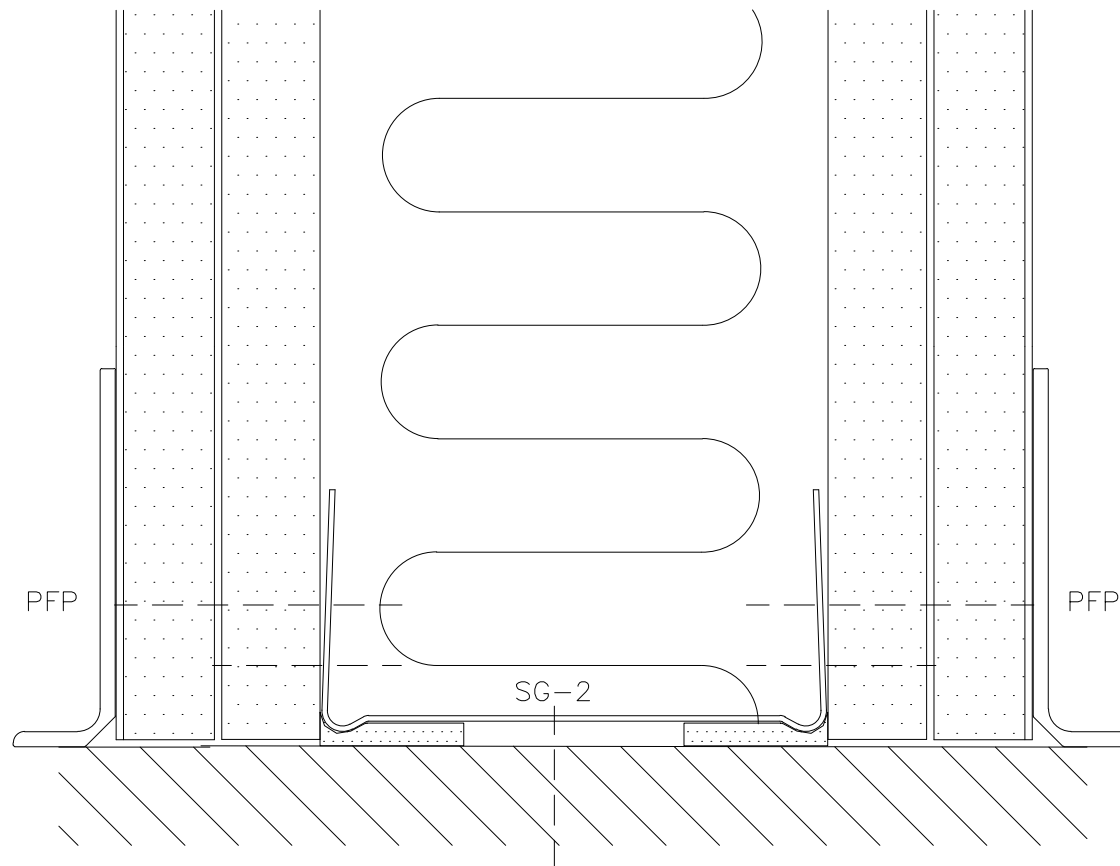

DEKO

Tlf./Tel: +45 43 55 77 11
www.deko.dk / www.deko.com

Projekt/Project:

DEKO PF 1290

Sags Nr./Case No.:

Emne/Subject:

Gulvtilslutning

L3B

Dato/Date:

Tegn. Nr.

Sheet No. 1/1

Mål/Scale

1:1

Revideret/Revision:

2016-05-01-V01

Signatur

Signature OP/EZ

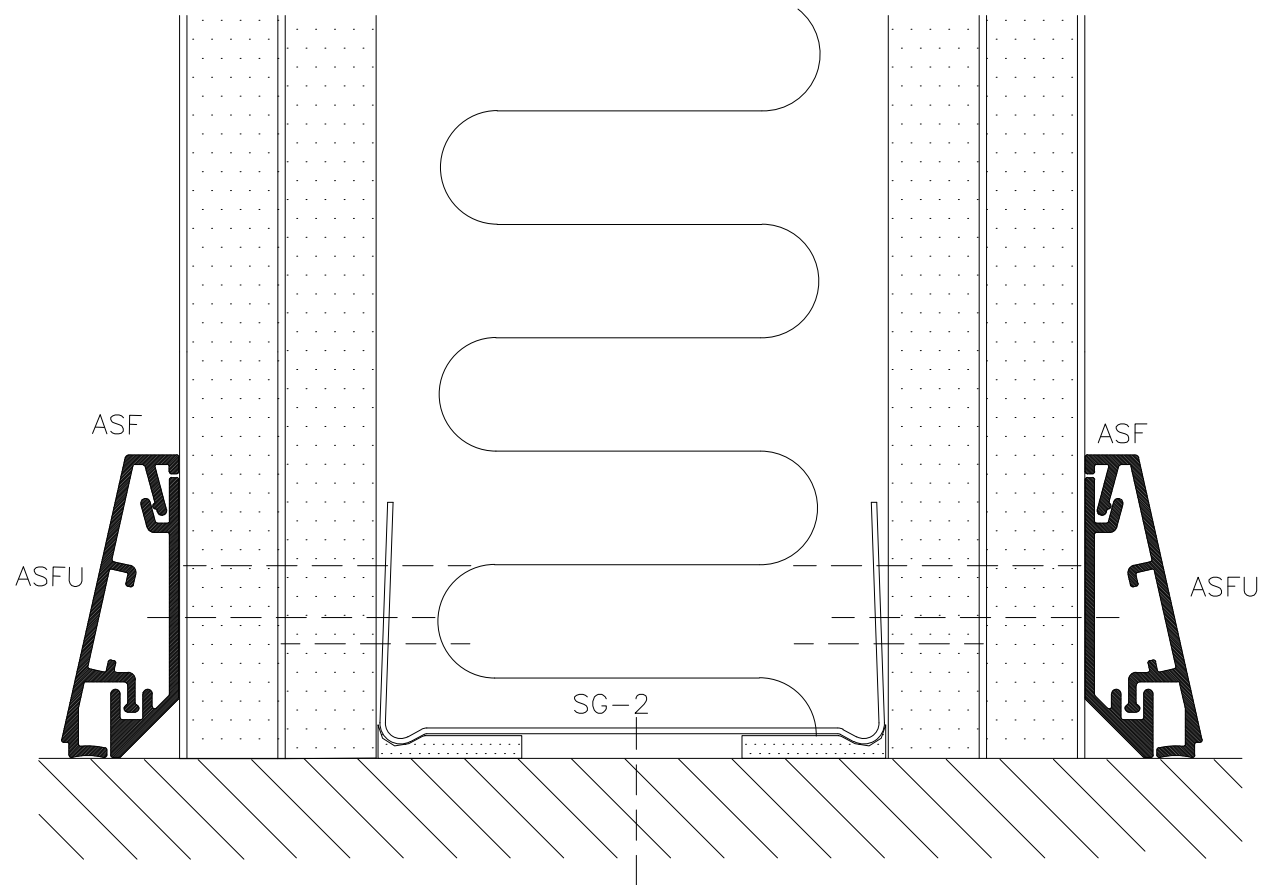

DEKO

Tlf./Tel: +45 43 55 77 11
 www.deko.dk / www.deko.com

Projekt/Project:

DEKO PF 1290

Sags Nr./Case No.:

Emne/Subject:

Gulvtilslutning

L3C

Dato/Date:

Tegn. Nr.

Sheet No. 1/1

Mål/Scale

1:1

Revideret/Revision:

2016-05-01-V01

Signatur

Signature OP/EZ

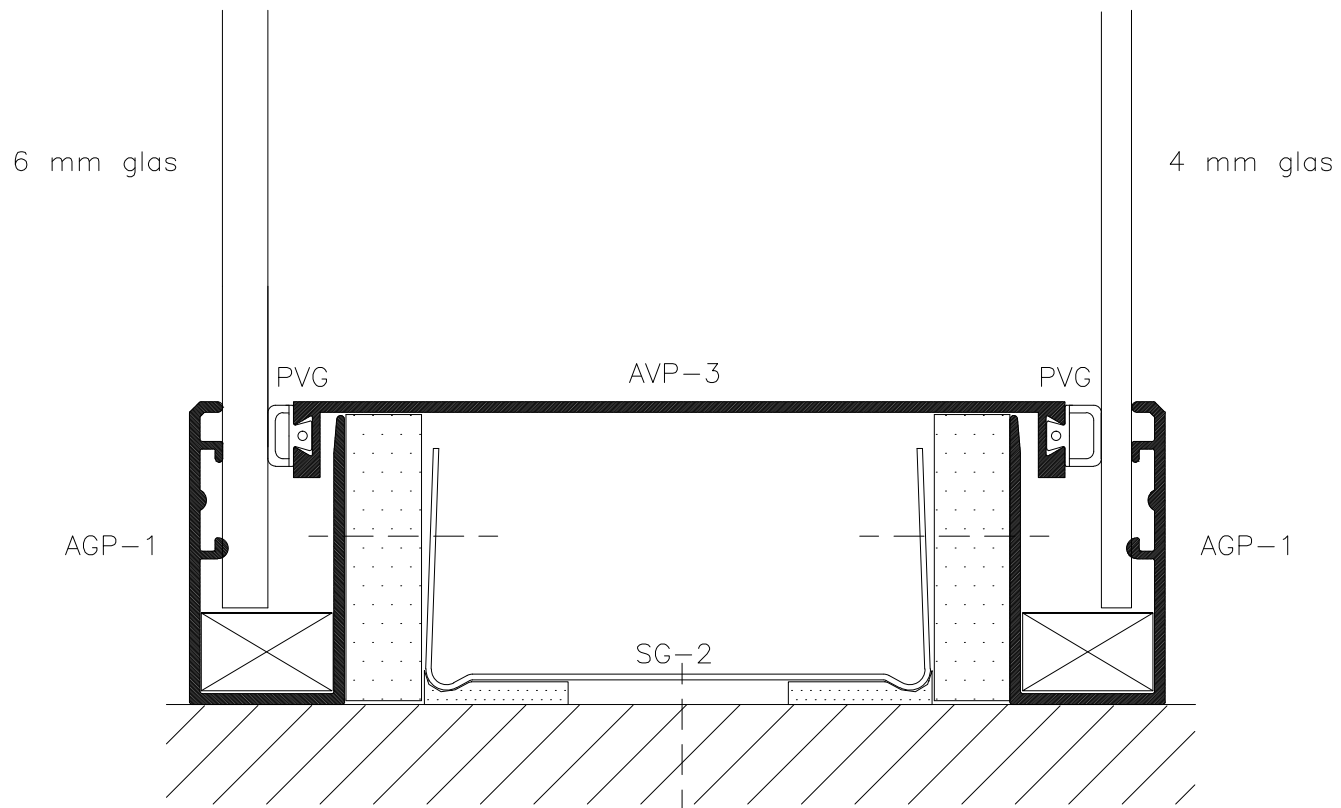

	DEKO Tlf./Tel: +45 43 55 77 11 www.deko.dk / www.deko.com		Projekt/Project: DEKO PF 1290		
	Sags Nr./Case No.:	Emne/Subject: Gulvtilslutning L3D		Dato/Date:	Tegn. Nr. Sheet No. 1/1
Mål/Scale 1:1			Revideret/Revision: 2016-05-01-V01	Signatur Signature OP/EZ	

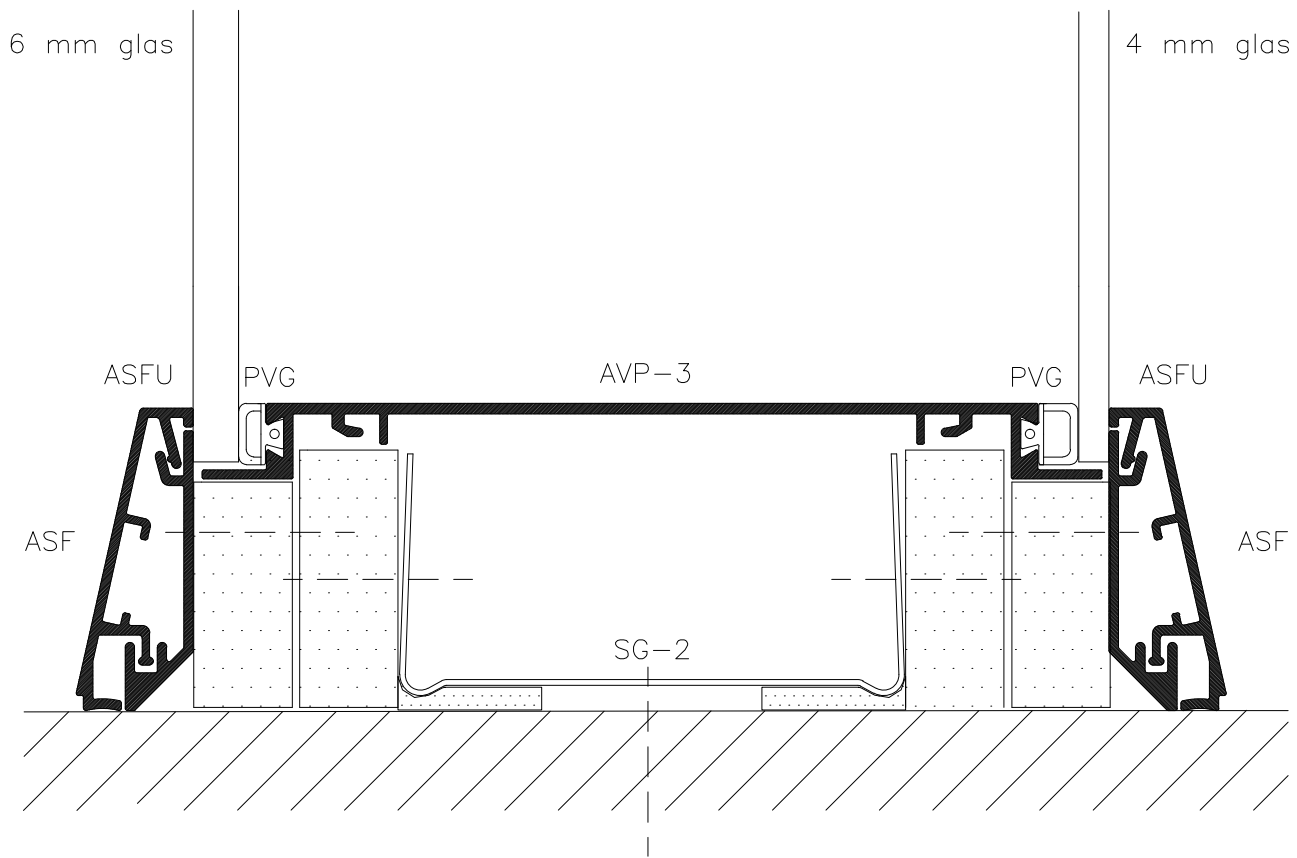

	DEKO Tlf./Tel: +45 43 55 77 11 www.deko.dk / www.deko.com		Projekt/Project: DEKO PF 1290	
	Sags Nr./Case No.:		Dato/Date:	Tegn. Nr. Sheet No. 1/1
	Mål/Scale 1:1		Revideret/Revision: 2016-05-01-V01	Signatur Signature OP/EZ

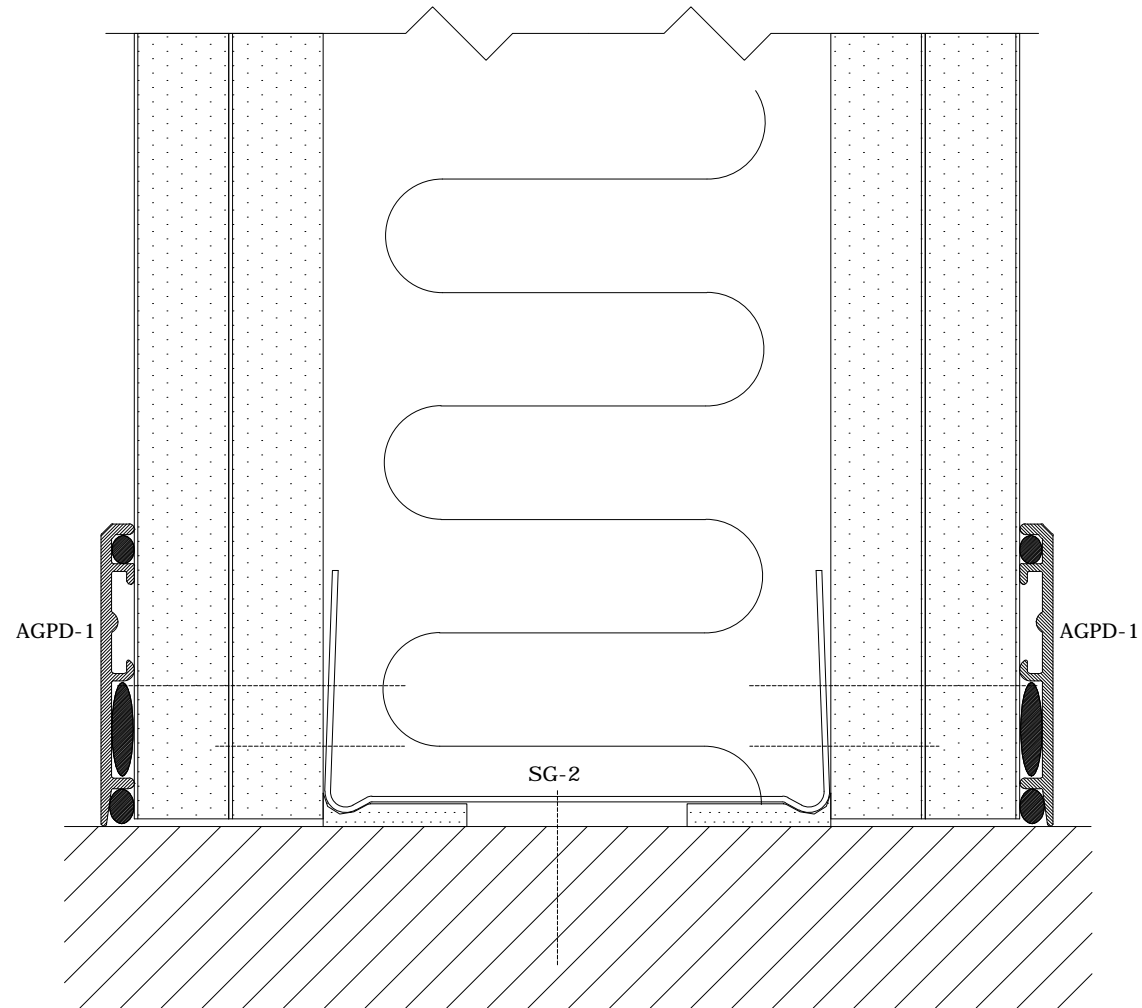

DEKO

Tlf./Tel: +45 43 55 77 11
 www.deko.dk / www.deko.com

Projekt/Project:

DEKO PF 1290

Sags Nr./Case No.:

Emne/Subject:

Gulvtilslutning

L3F

Dato/Date:

Tegn. Nr.

Sheet No. 1/1

Mål/Scale

1:1

Revideret/Revision:

2016-05-01-V01

Signatur

Signature OP/EZ